

LYRA ECLIPSE White High Efficiency HD IP40

Area: **Design Luminaires**

Category: **Design Luminaires**

Mounting: **Ceiling mount / Recessed mount**



Poetic dance of light and darkness. An elegant circular pendant luminaire with inner lighting. An eye-catcher in every lounge, mall or lobby.

- Small cross section with minimal pendant and supply cable for a refined design with clean finish.
- Available in 806 mm or 1,164 mm diameter.
- Various lumen outputs up to 4,950 lm.

Detailed specification text in download section.

DIMENSIONS & AVAILABLE LENGTHS

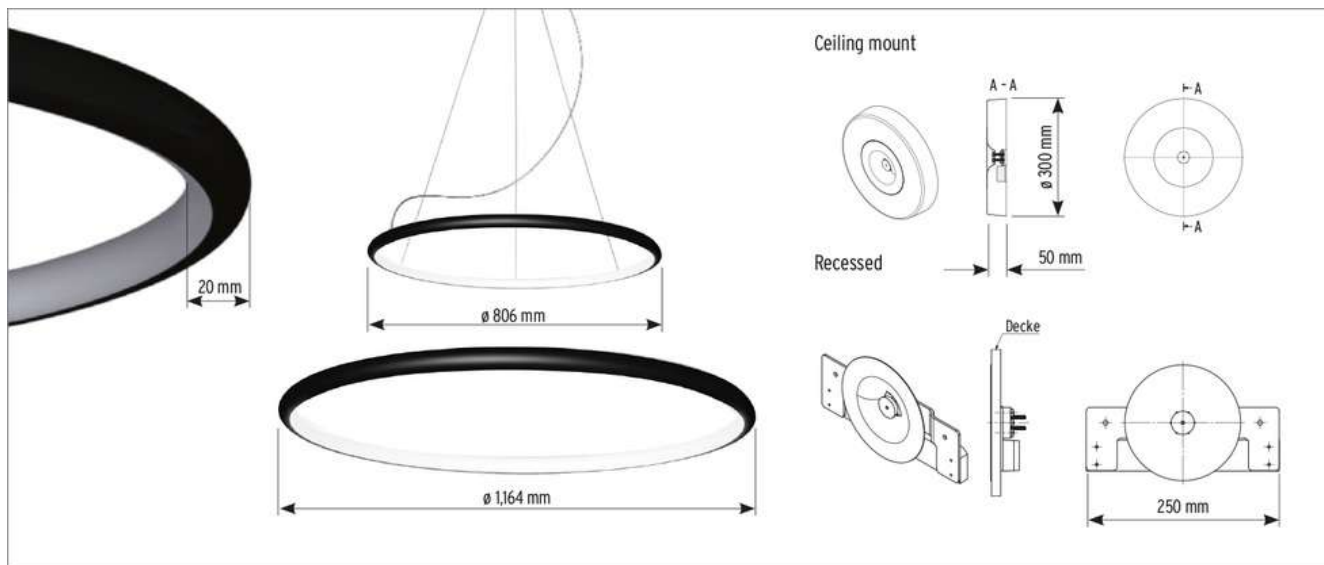

2 Standard diameters: 806 mm / 1,164 mm

TECHNICAL SPECIFICATIONS

Certifications













Awards



Family Key Features



Technical Data/Performance

 Static White	 IP40	 L80/B10 >60,000 h	 OneBinOnly	 Wxxx / 339	 SDCM3	 S-025 compliant	 LM80 compliant
 Reel-to-Reel (R2R)	 Protection against granular objects > 1 mm	 Compliant with EU ECODESIGN guidelines					

ELECTRICAL & OUTPUT DATA

Voltage	24 Volt (23 V _{min} , 25 V _{max})
Case Temperature (T _{Cmin} & T _{Cmax})	T _{Cmin} = -25°C, T _{Cmax} = specific, see Table below
Storage Temperature (T _{Smin} & T _{Smax})	T _{Smin} = -30°C, T _{Smax} = 85°C
Ambient Temperature (T _{Amin} & T _{Amax})	T _{Amin} = -25°C, T _{Amax} = specific, see Table below

LYRA ECLIPSE White High Efficiency HD IP40	HD15	HD25
Power (W/m) ^B	15	25
Efficacy (lm/W) ^B	69	58
Diameter (m)	1.17	0.81
CRI / R9 (up to)	85 / 32	85 / 32
Temperature T _C -point (T _{Cmax}) ^C	70°C	75°C
max. ambient temp. (T _{Amax})	45°C	45°C

LYRA ECLIPSE White High Efficiency HD IP40		HD15	HD25
Color temperature	luminaire lumens/meter (lm/m) ^A		
● W820 2,000K	1050	1840	
● W822 2,200K	1210	1950	
● W825 2,500K	1380	2230	
● W827 2,700K	1460	2370	
● W830 3,000K	1550	2520	
● W835 3,500K	1620	2640	
● W840 4,000K	1670	2700	
● W850 5,000K	1810	2950	

! To configure the specific luminaire please use the online configurator.

Please note: The orange values are CRI 90 specifications.

^AWithout cover the IP protection level is reduced from IP40 to IP10.

^BThe given data are typical values. Due to tolerances of the production process and the electrical components, photometric values and electrical power can vary up to 10%

^CThe T_C-point should be measured in thermal equilibrium according to IEC EN 60598-1.

! Note: -40% luminous flux at opal and -25% with diffuse cover.

ORDER CODE

Example:

LYRA ECLIPSE HYD **HD15 W820 806-S-OR-C** IP40

CONFIGURE NOW!

Options for the order code:

Your selections :

LED tape

- HD15 (15 W/m) HD15
- HD25 (25 W/m) HD25

Color temperature

- 2,000 K W820
- 2,200 K W822
- 2,500 K W825
- 2,700 K W827
- 3,000 K W830
- 3,500 K W835
- 4,000 K W840
- 5,000 K W850

Please note: The orange values are CRI 90 specifications.

- 806 mm 806
- 1164 mm 1164

Housing color

- Silver S
- Black B

Mounting type

- Ceiling mount C
- Recessed R

MOUNTING

1. Ceiling mount

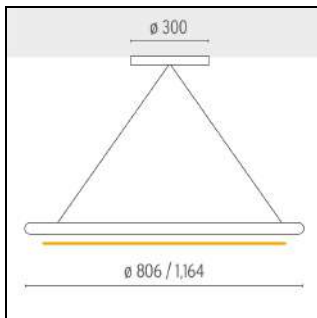

Mounting accessories



Ceiling Mount Canopy

Description

Pre-mounted canopy for ceiling installation; pendant set included.

Example of application



2. Recessed mount

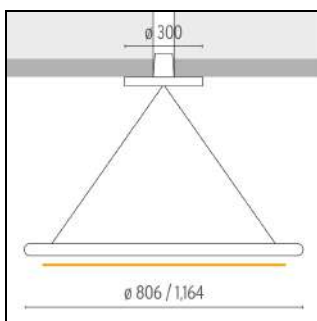

Mounting accessories



Recessed Mount Canopy

Description

Pre-mounted canopy for recessed installation; pendant set included.

Example of application

