











IP67

CALIBER 80 HV



Caliber 80 HV is an extremely efficient compact in-ground LED up-light directly powered on Line Voltage, designed for optical excellence and engineered for complete resilience. Caliber 80 HV offers a choice of three colour temperatures as standard (2700K, 3000K and 4000K) and delivers 90 CRI for excellent colour rendering, and with binning-free LEDs carefully selected from two-step MacAdam's ellipses, colour consistency is assured throughout the unonovesette portfolio. With a deep recess of the in-house designed PCB, Caliber 80 HV offers excellent glare control.

Caliber 80HV è un apparecchio a LED dalle dimensioni compatte da incasso a pavimento ed estremamente efficiente, alimentato direttamente con la tensione di rete, ideato con un'ottica eccellente e progettato per una completa flessibilità. Caliber 80HV offre una scelta fra tre temperature di colore come standard (2700K, 3000K e 4000K) tutte con CRI maggiore di 90 per una eccellente resa cromatica. Binning-free e due-step MacAdam's ellipses LED, assicurano consistenza del colore in tutte le versioni previste da unonovesette. Con l'elettronica progettata internamente e ben posizionata, Caliber 80HV offre un eccellente controllo dell'abbagliamento.

TECHNICAL DATA / DATI TECNICI:

 IP67	 2700K / 3000K / 4000K
 6W	 10° / 30° / 50° / 10°x45° / Satin
 540 lm (3000K)	 Smart Shield
 >90	 Vac 100-240 50/60Hz
	

FINISHES / FINITURE:

	Stainless steel AISI316L Acciaio INOX AISI316L
	Aged solid brass Ottone anticato
	Pre-aged solid brass Ottone pre-anticato

OPTICS / OTTICHE:

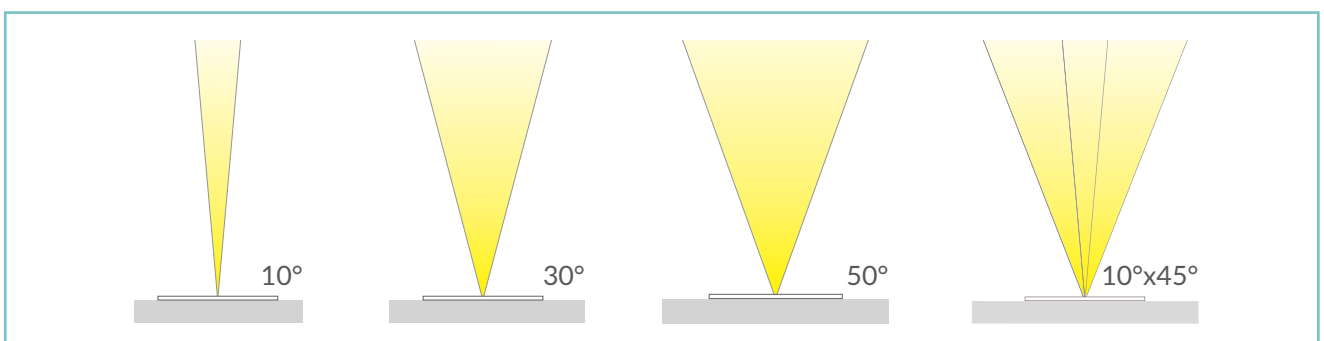



unonovesette

PRODUCT CODE / CODICE PRODOTTO:

C8H = CALIBER 80HV		Select one component from each column to specify a complete configuration: <i>Selezionare un componente per ogni colonna per la configurazione completa:</i>			
		LED colour / Colore LED	Optics / Ottiche	Finish / Finiture	Power / Potenza
		27 = 2700K 30 = 3000K 40 = 4000K	N = 10° M = 30° W = 50° E = 10°x 45° S = Satin / <i>Satinato</i>	03 = Stainless steel AISI316L / <i>Acciaio INOX AISI316L</i> 10 = Aged solid brass / <i>Ottone anticato</i> 21 = Pre-aged solid brass / <i>Ottone pre-anticato</i>	06 = 6W

Standard configuration example/
Esempio di configurazione standard:

C8H.30.N.03.06 Caliber 80 HV 3000K 10° optics stainless steel / *Acciaio INOX 6W*

ACCESSORIES / ACCESSORI

			
Housing box <i>Cassaforma</i> HB.006 (270g)	Honeycomb louver <i>Schermo alveolare</i> ACC.004	Anti-Glare louver <i>Frangiluce</i> ACC.073	Cable Cavo CV00094 5m CV00095 10m

CALIBER 80 HV

TECHNICAL DRAWING / DISEGNO TECNICO:

RECESSED HOLE / FORO INCASSO:

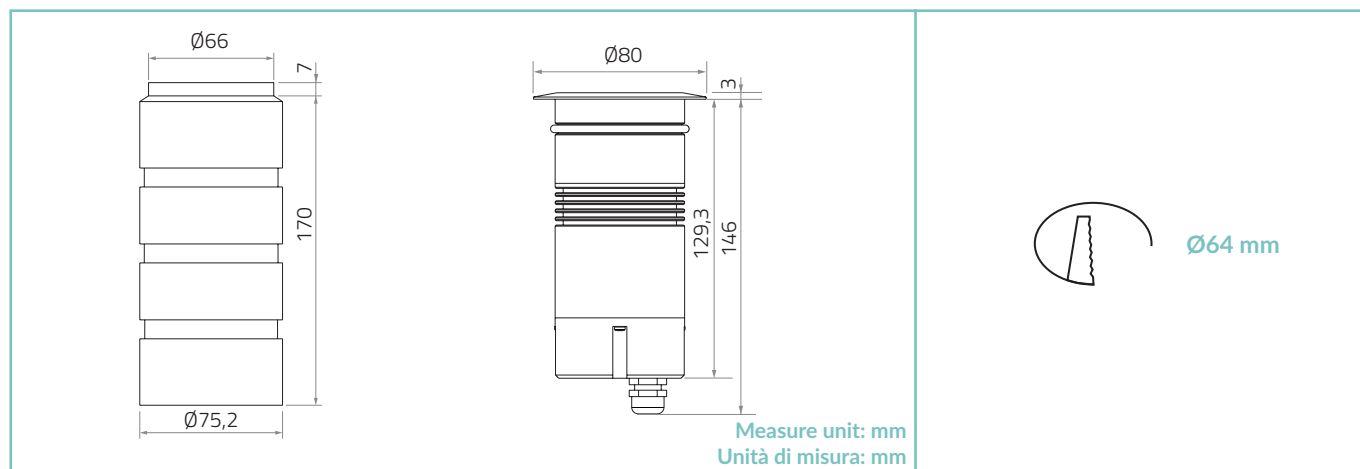

TECHNICAL SHEET / SCHEDA PRODOTTO:

Body: Stainless Steel AISI316L - Anodized aluminium 6026 / Solid brass
- Anodized aluminium 6026

Glass: Tempered extra clear / frosted glass 6mm

Finishes: Stainless Steel AISI316L / Aged solid brass / Ottone pre-anticato

Installation: Housing box

Power supply cables: 35cm H05RNF PCP 3x0,5mm²

Power supply: 100-240 Vac 50/60Hz

Power consumption: 6 Watt

CRI: >90

Bin selection: Binning free 2 step MacAdam's

Lumen output (source): 540 lm (3000K)

Lumen output (delivered): 436 lm (3000K)

Operating temperature: -20°C +50°C

IP rating: IP67

Insulation class: Class I

Impact resistance: IK08

Weight: 640g

Optics: 10° / 30° / 50° / 10°x 45° / Satin

LED colour temperature: 2700K / 3000K / 4000K

Lifetime LED: 50000h L95 B10 (Ta 25°C)

Photo biological risk: RG0 / RG1

Corpo: Acciaio INOX AISI316L - Alluminio 6026 anodizzato / Ottone - Alluminio 6026 anodizzato

Vetro: Vetro temprato extra chiaro o satinato 6mm

Finiture: Acciaio INOX AISI316L / Ottone anticato / Ottone pre-anticato

Fissaggio: Cassaforma

Cavo di alimentazione: 35cm H05RNF PCP 3x0,5mm²

Alimentazione: 100-240 Vac 50/60Hz

Potenza assorbita: 6 Watt

CRI: >90

Selezione bin: Binning free 2 step MacAdam's

Flusso sorgente: 540 lm (3000K)

Flusso apparecchio: 436 lm (3000K)

Temperatura di funzionamento: -20°C +50°C

Grado di protezione: IP67

Classe d'isolamento: Classe I

Protezione impatto: IK08

Peso: 640g

Ottiche: 10° / 30° / 50° / 10°x 45° / Satinato

Temperatura colore LED: 2700K / 3000K / 4000K

Vita media LED: 50000h L95 B10 (Ta 25°C)

Rischio fotobiologico: RG0 / RG1

PHOTOMETRICS/CURVE FOTOMETRICHE:

10° - 6 Watt

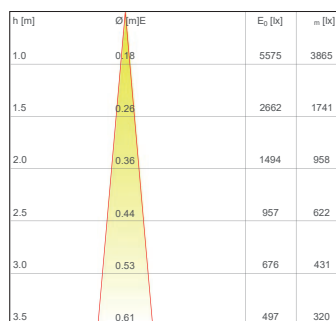

— C0 - C180 (10,0°)

30° - 6 Watt

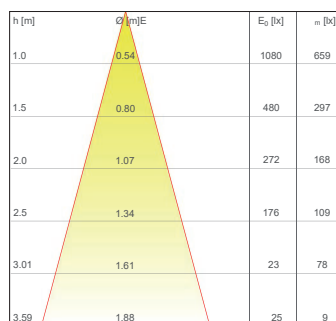

— C0 - C180 (30,0°)

50° - 6 Watt

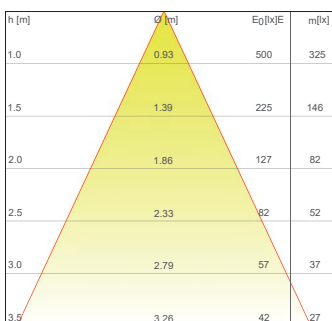

— C0 - C180 (50,0°)

10°x45° - 6 Watt

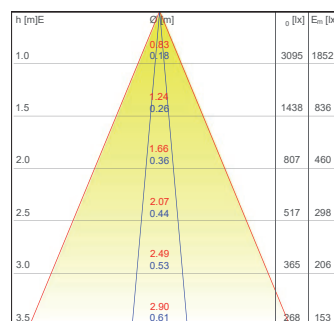

— C0 - C180 (45,0°) — C90 - C270 (10,0°)