

THORN
LIGHTING

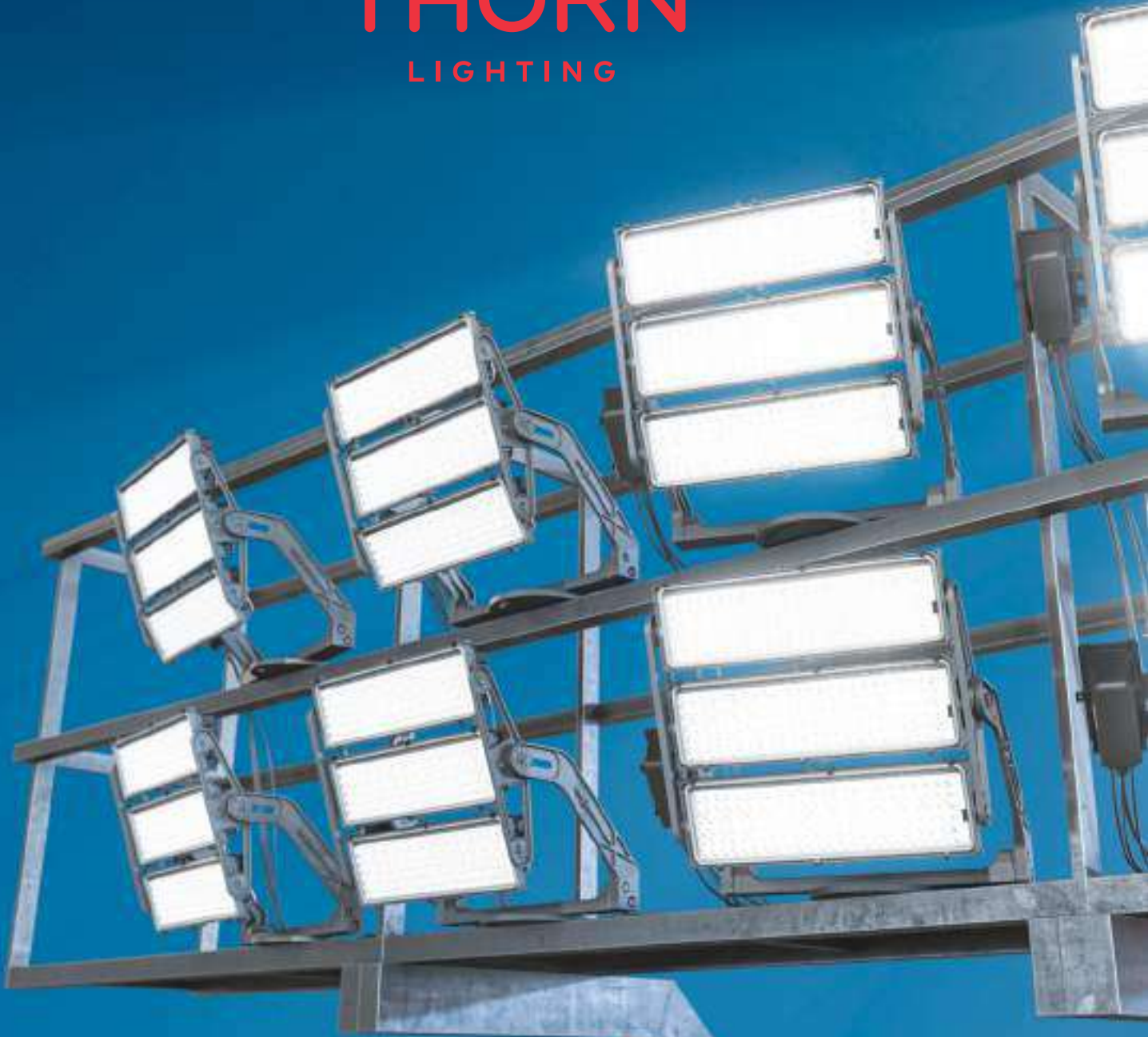

ALTIS

The most powerful light, controlled

CONTROLLED LIGHT POLLUTION. MAXIMUM POWER.

The new Altis is a powerful, flexible and easy to install, LED floodlight with up to 256,000 lumens.

For a wide-range of sports and high column area lighting applications, Altis offers numerous CCT/CRI/TLCI (3000 K, 4000 K and 5700 K, CRI from 70 to 90+ and TLCI up to 90+) as well as colour changing configuration options (RGBW and Balanced White). In addition to flicker-free operation for HDTV broadcasting, it also provides mixed optics. Thanks to its tiltable LED modules, it enables installation design optimisation, with a minimum number of floodlights.



Stadia
& arenas



Recreational
sports



Multi-sports
halls



Swimming
pools



Transportation &
industrial areas



Façades



Light
shows



INNOVATION DELIVERS OPTIMAL PERFORMANCE

Altis is available in 1, 2 or 3-module versions, allowing for a variety of optical configurations and installation options – from horizontal for reduced obtrusive light (0 cd at 90°) to tiltable (+/-60°) for sports applications. Spill light control and a ULOR of 0 % were once best served with a 3 module version however, a new 2 module version now can offer the same protection.

Different optics can be mixed in each module. The ability to tilt the floodlight allows the lighting design to be optimised. This delivers several benefits including fewer floodlights, perfect uniformity on the playing area and greatly reduces windage.



3 LED MODULES
(504/480/456/432 LEDS)



2 LED MODULES
(336/312/288 LEDS LB)

HIGH PERFORMANCE

Whether large stadium, recreational field or area floodlighting, the compact patented driver delivers high performance in all types of installations. Its improved lifetime also makes it an attractive retrofit solution.



Gearbox



FLEXIBLE AND INTUITIVE DESIGN

Offering maximum flexibility, the different optics in Altis can be combined in the luminaire structure to create the right light solution for specific applications. Not only flexible, the floodlight is easy to install with handling possible from the lateral arms and it offers multiple installation positions.

The process is also made quicker and more efficient still with a quick fix connection box and the easy plug-in connectors for the luminaire and for the gearbox. The connection box can be attached at different places on the luminaire structure and cable guidance behind the LED modules gives a secure place to hold all the cables together. With the new angle indication for each LED module and arm it is simple to use for quicker and precise luminaire aiming.



1 LED MODULE
(168/144 LEDS)

2 LED MODULES
(336/312/288 LEDS)



MULTI PATENTED INNOVATIONS INCLUDED

Altis is a truly innovative luminaire due to the concept that provides a comparable high exchange area to volume ratio. This means there is multi directional air flow resulting in reduced pressure loss, improved air flow that creates a good balance between high cooling abilities and low impact drag forces.

Designed with the user in mind. With a customer friendly lateral arm, a lightweight body with high structural vibration resistance, and also the adjustable precision setting that allow for accurate and fast LED module tilting and orientation.

As if two unique features weren't enough, there is also the patented fishbone concept on the gearbox, and aerodynamic component for a flat floodlight.

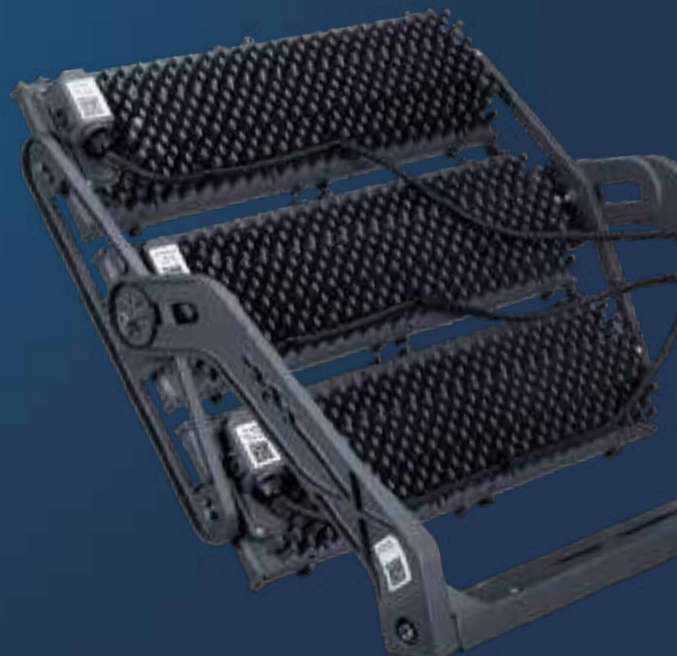

LIGHT JUST RIGHT FOR TV

At stadiums that host televised events, lighting specifications for HD, 4K TV and super-slow motion capabilities are key. Altis scores 90+ on the TLCI (Television Lighting Consistency Index), which broadcasters use to evaluate the performance of lighting for television. Altis illuminates the athletes and the on-field action so that TV cameras will capture bright and colourful images, providing an optimal viewing experience.



BEST-IN-CLASS LIGHT

With our integrated electronic providing gearboxes with a flicker factor <1% as a standard, Altis offers slow motion broadcasting up to 1000 fps, to enable TV broadcasters to film super-slow-motion replays with no visible flicker.

LIGHT WHERE YOU NEED IT

A floodlight should precisely illuminate the intended area. It is important that scattered light reaching neighbouring buildings is minimal and that players and spectators are not dazzled.

Altis can be equipped for different light distributions, including asymmetric for area and symmetric for sports applications. Asymmetrically, it focusses the light forward at 0° tilt with a defined cut-off to reduce artificial sky glow, glare and intrusive light.



MINIMISING WINDAGE

Windage is the force generated by wind on an object such as a floodlight. Altis greatly minimises windage through combined frame and modules tilting up to 70°. Thorn floodlights are tested to optimise tilting and keep windage to a minimum.

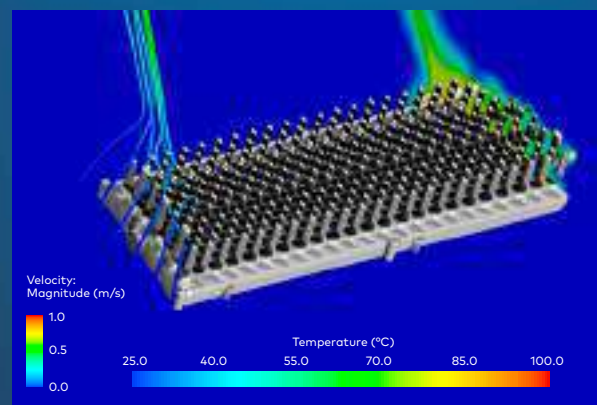

THERMAL OPTIMISATION

We perform thermal and fluid-dynamic simulations, to optimise Altis geometry, to guarantee safe operation, and lifetime performance.

SYMMETRICAL LIGHTING DISTRIBUTIONS

NB / MB / WB

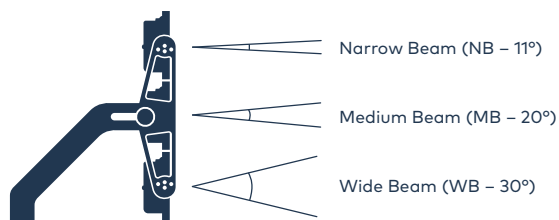

ELLIPTICAL LIGHTING DISTRIBUTION

EB

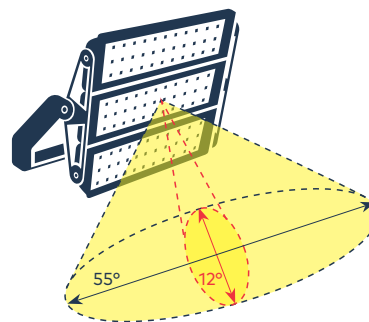

ASYMMETRICAL LIGHTING DISTRIBUTIONS

A4 / A5 / A6 / A15 / A16 / EW / AW3

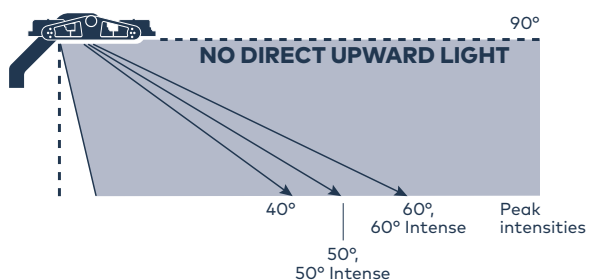

To help with uniformity on medium and large scale outdoor sports fields, 40/50/60° versions are available. Coming soon there will be an Asymmetric Intense 30° light distribution. Additionally an Asymmetric Wide will be available for lighting plans of small size outdoor and indoor sports fields.

PLAY WITH COLOURS

CREATE A UNIQUE IDENTITY

Turn your stadium into a space of experience by offering colourful animations with the Altis RGBW option. You can light up the roof, highlight the facade or even create roof lighting with customised colour patterns. Spectators will be able to experience a unique look and feel while watching specially highlighted sport actions. Events and concerts will become even more memorable with the playful lighting scenarios by Altis RGBW.



BALANCED WHITE: DYNAMIC LIGHT FOR MAXIMUM FLEXIBILITY

Tune the colour temperature from the warmest 2700 K all the way to 5700 K and completely transform the atmosphere of your sports hall. During trainings, a warmer colour temperature of 3000 K is preferred. While during competitions a cooler one, between 4000 K and 5700 K is needed. This can also vary from country to country as regulations change and, in some cases, certain requirements are specified by law. With Altis Balanced White you are able to adjust colour temperatures to suit the mood and requirements of the respective event, game, or match. Easily tune your sport with either DALI-2 or DMX-RDM control.



CONTROL SOLUTIONS

ADJUSTING LIGHT TO SUIT YOUR NEEDS

Altis is available in complete lighting management packages for wide-ranging professional and recreational sports applications, both indoors and outdoors. Designed to provide safety and comfort for players, our control solutions fully meet relevant sports lighting requirements. They also increase energy savings and provide more flexibility.

FULLY INTEGRATED CONTROL PACKAGE

With the scalable control solution, Altis enables customisable, pre-programmed lighting effects with real-time overrides and supports Art-Net, DMX RDM and DALI protocols. The system's integrated lighting console also enables remote control of building management, audio and perimeter advertising systems.



Lighting playback controller with touch panel (in-or external)

SERVICES:

- Commissioning and addressing
- Controls programming
- Web page creation with custom user interface design
- Integration of stand lighting control subsystems (DALI, DMX and hybrid)
- On-site technical consultation meetings
- Training of operating personnel
- Technical support
- Control solution for the entire stadium, from the pitch lighting to the facade and interiors

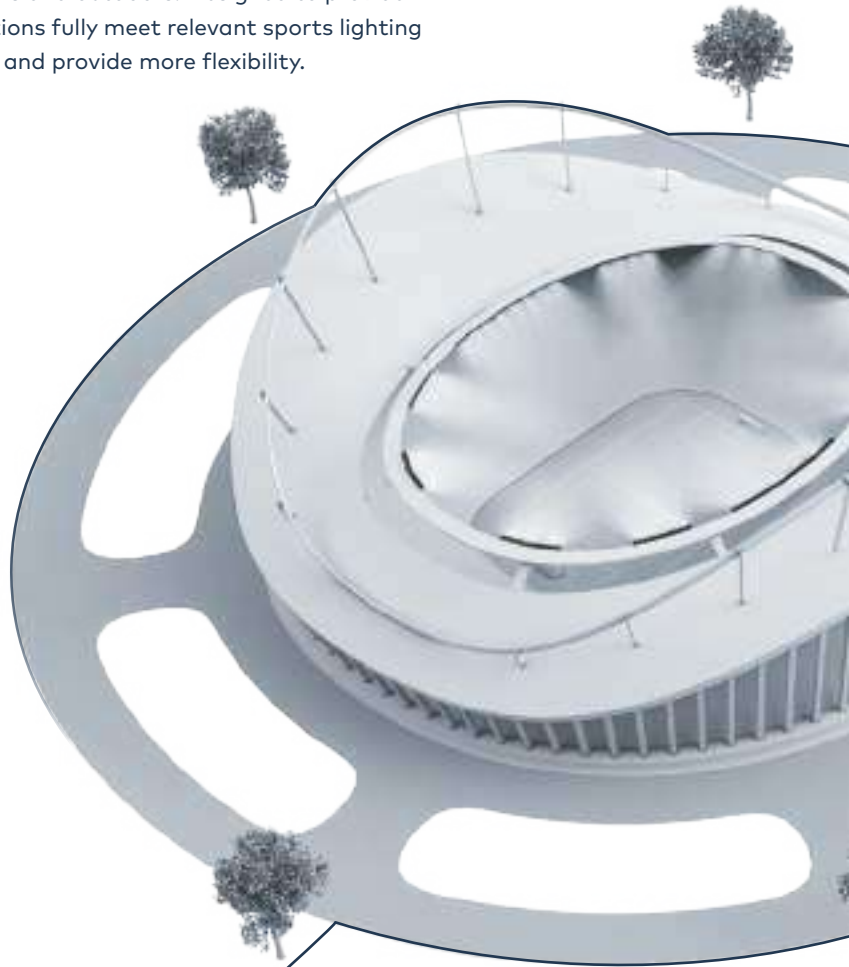

BASIC CONTROL PACKAGE

Using a locally installed control cabinet, this switching and dimming package enables control of a group of lighting points, when needed. The solution offers good energy savings while still providing all of the required lighting on demand. Light settings can also be pre-programmed. New installations and refurbishments can benefit from Thorn's UrbaSens Play, with wireless communication and simple app-based control.

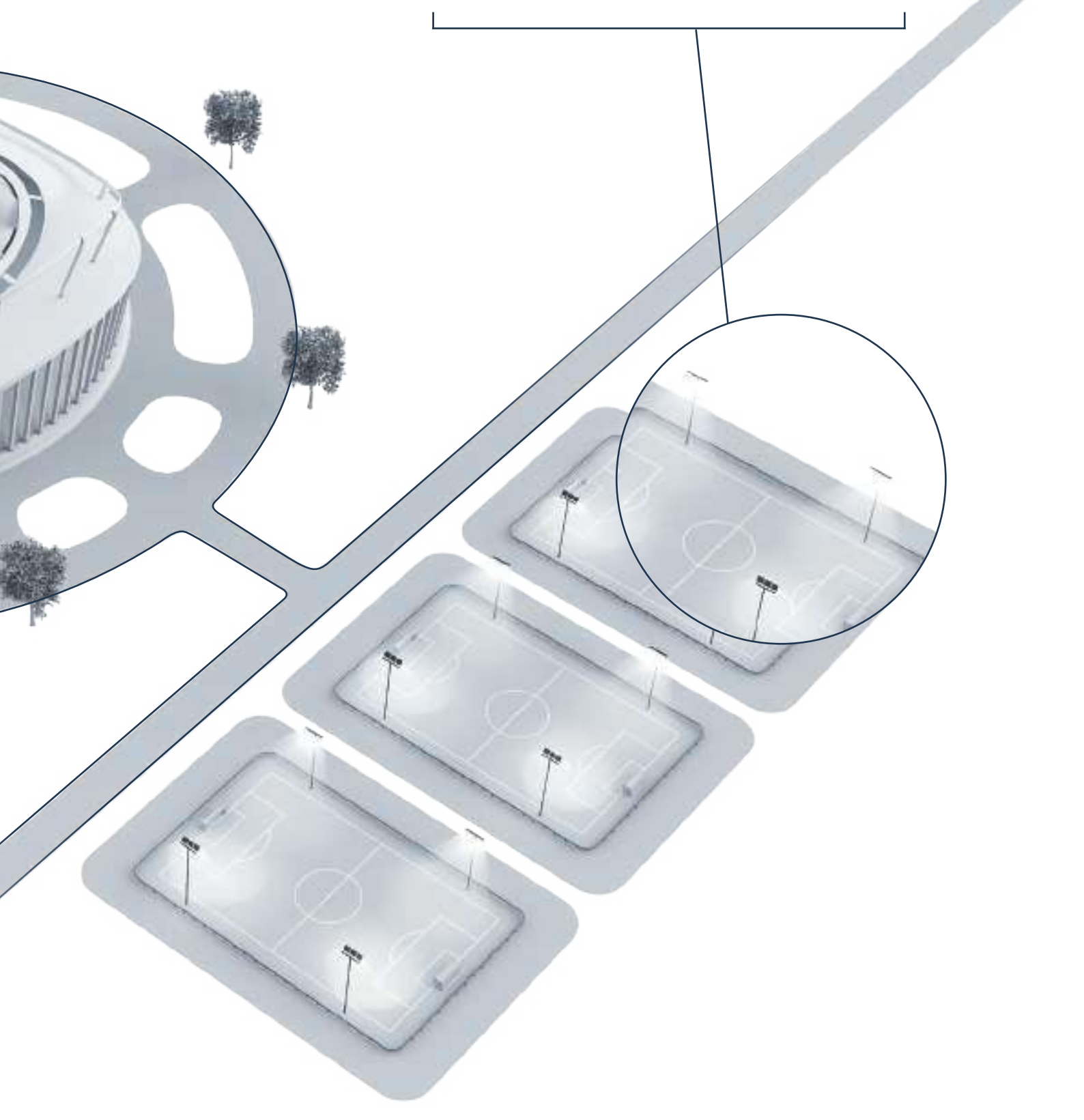

INSTALLATION POSSIBILITIES

Altis can be configured for virtually any lighting design. Modules are easy to adjust with the patented precision settings that are specially designed for accurate and fast LED module tilting and orientation. The flexible gearbox IP66 enables installation directly in the back of the bracket, remotely up to 200 m, inside distribution boards, electrical rooms, on the masts and more. Post-top, surface and wall mounted options are available.

MOUNTING OPTIONS

Direct lighting

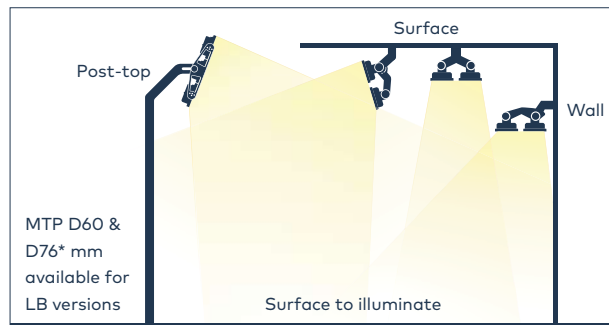

Indirect lighting



*Post-top mounting adaptor (MTP D60/D76) to fit luminaire to Ø60 and to Ø76 mm column

ROTATION OPTIONS

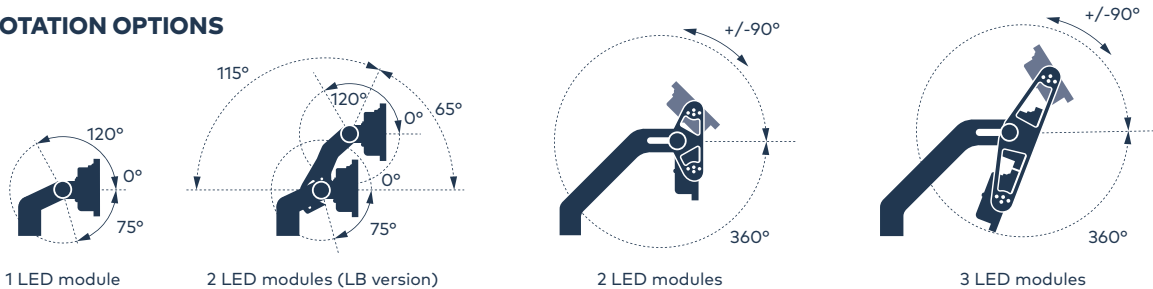

ACCESSORIES



AIMING DEVICE

To direct the orientation of the luminaire, for symmetric as well as asymmetric aiming.



LOUVRE

External louvre for asymmetric or symmetric optics to limit spill light.



JUNCTION BOX

Allows the connection of different modules.

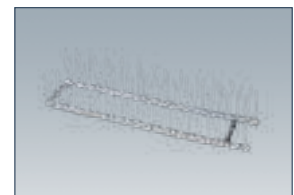

BIRD DETERRENT

Prevent birds from landing on and damaging the floodlight.



VISOR

External visor, adjustable in angle and length, to create precise light cut-off on-site.



DRIVER STIRRUP MOUNTING BRACKET

Enables gearbox mounting to the floodlight stirrup.



DRIVER STIRRUP MOUNTING BRACKET LB

Enables gearbox mounting to the floodlight stirrup light bracket (LB), including fixing of the junction box.

DISCOVER

ALTIS



	144 / 168 LEDs 1 Module	336 / 312 / 288 LEDs LB 2 Modules	336 / 312 / 288 LEDs 2 Modules	504 / 480 / 456 / 432 LEDs 3 Modules
	Up to 85,000* lm	Up to 170,000* lm	Up to 170,000* lm	Up to 256,000* lm
	Up to 160 lm/W			
	3000 K / 4000 K / 5700 K / RGBW / Balanced White (2700 K – 5700 K)			
CRI	70 / 80 / 90			
TLCI	Up to 90+			
	IP66			
	-40°C to 45°C			
	IK08			
	Ball proof			
	10 kV surge voltage protection			
	Max 9.6 kg Gearbox IP66: max 5.7 kg	Max 18.7 kg Gearbox IP66: max 5.7 kg	Max 23 kg Gearbox IP66: max 5.7 kg	Max 30.8 kg Gearbox IP66: max 6.5 kg
	Resistant to seaside and swimming pool environments Corrosion resistant (Class 5 – Very High)			
	100 000 h L90B10			
	Narrow beam (NB) / Medium beam (MB) / Wide beam (WB) / Elliptical beam (EB) / Asymmetrical 40° (A4) / Asymmetrical 50° (A5) / Asymmetrical 60° (A6) / Asymmetrical Intense 50° (AI5) / Asymmetrical Intense 60° (AI6) / Extra Wide (EW) / Asymmetrical Wide 30° (AW3)			
	0.06 at 0° / 0.07 at 15° / 0.12 at 45° / 0.16 at 65° / 0.17 at 90°	0.16 at 0° / 0.19 at 15° / 0.30 at 45° / 0.32 at 65° / 0.35 at 90°	0.16 at 0° / 0.19 at 15° / 0.30 at 45° / 0.35 at 65° / 0.37 at 90°	0.18 at 0° / 0.23 at 15° / 0.40 at 45° / 0.50 at 65° / 0.52 at 90°
	Luminaire: Texturised anthracite (different RAL on request) Gearbox: Texturised light grey			
	Flicker <1%			
	Fixed Output (HF), DALI-2 (DA), DMX RDM (RDMX), DALI-2 with dimming preset (DA BP), DALI-2 with Constant Light Output preset (DA CLO)			

*Data refers to system level, and to the narrow beam version



CONFIGURATION GUIDE

LUMINAIRE

ALTIS G5	288L	85	857	WB	PTR	LB	ANT
Range	LED	Driving Current	CCT/CRI	Optic	Application	Stirrup	Colour
							GY-S GY ANT BK
						LB	
							Light bracket 2 bricks stirrup
					PST		
					PST35		
					PTR		
					PTR35		
					PAR		
					PAR35		
					PIC		
					PIC35		
					PIT		
					PIT35		
				NB			
				MB			
				WB			
				EB			
				A4			
				A5			
				A6			
				A15			
				A16			
				EW			
				AW3			
				XxXxXx			
			730				
			740				
			757				
			857				
			957-T86				
			957-T90				
		140					
		125					
		105					
		85					
		70					
	504L						
	480L						
	456L						
	432L						
	336L						
	312L						
	288L						
	168L						
	144L						
ALG5	Altis						

Bricks: Texturised light grey / Body*: Unpainted
 Bricks: Texturised light grey / Body*: Texturised light grey
 Bricks: Texturised anthracite / Body*: Texturised anthracite
 Bricks: Texturised anthracite / Body*: Texturised black

CRI 70 3000 K
 CRI 70 4000 K
 CRI 70 5700 K
 CRI 80 5700 K
 CRI 90 5700 K – TLCI 86
 CRI 90 5700 K – TLCI 90

Maximum driving current 1400 mA
 Maximum driving current 1250 mA
 Maximum driving current 1050 mA
 Maximum driving current 850 mA
 Maximum driving current 700 mA

504 LEDs (3 LED Modules, Symmetrical)
 480 LEDs (3 LED Modules, 1xAsymmetrical, 2xSymmetrical)
 456 LEDs (3 LED Modules, 2xAsymmetrical, 1xSymmetrical)
 432 LEDs (3 LED Modules, Asymmetrical)
 336 LEDs (2 LED Modules, Symmetrical)
 312 LEDs (2 LED Modules, 1xAsymmetrical, 1xSymmetrical)
 288 LEDs (2 LED Modules, Asymmetrical)
 168 LEDs (1 LED Module, Symmetrical)
 144 LEDs (1 LED Module, Asymmetrical)

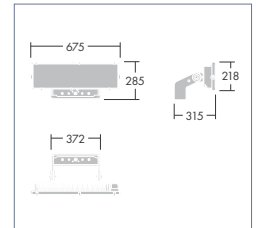

ALTIS 144L/168L

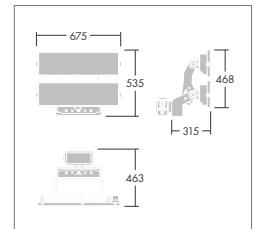

ALTIS 288L/312L/336L

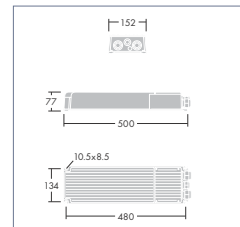

ALTIS PERFORMANCE GEARBOX

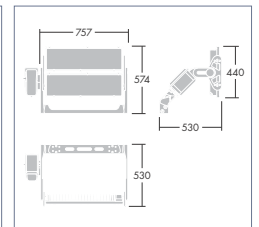

ALTIS 288L/312L/336L

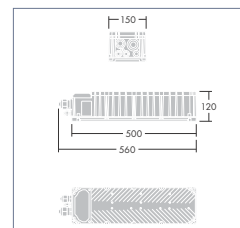

ALTIS PREMIUM GEARBOX

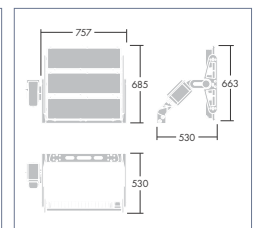

ALTIS 432L/456L/480L/504L

GEARBOX

GEARBOX	2CH	85	200-400	DA
Range	Power	mA	Voltage	Controls
				DMX RDM DALI-2 and autonomous dimming
			200-400	DA
		140	1400 mA**	DA
		125	1200 mA**	
		105	1050 mA**	
		85	850 mA**	
		70	700 mA**	
		xxx	xxxxx mA max Output	
	3CH			Voltage range
	2CH			
		For 3 LED modules		
		For 2 LED modules		
ALG5 GB		Altis Premium Gearbox		
ALG5 GB LE		Altis Performance Gearbox		

*Body: it includes: Frame, Fork, Bracket

**The ambient temperature and the power rating have an influence on the useful lifetime of the luminaire.

Configure the ideal product solution with myProduct. The myProduct configurator allows you to easily configure a luminaire according to your needs.

Try it now at www.thornlighting.com/myproduct



As a globally leading luminaire manufacturer, Thorn Lighting provides a five-year warranty for its complete product range within all European Countries.
thornlighting.com/guarantee

Thorn Lighting is constantly developing and improving its products. All descriptions, illustrations, drawings and specifications in this publication present only general particulars and shall not form part of any contract. The right is reserved to change specifications without prior notification or public announcement. All goods supplied by the company are supplied subject to the company's General Conditions of Sale, a copy of which is available on request. All measurements are in millimetres and weights in kilograms unless otherwise stated.
 10/2023 (INT)

**WE
MAKE
LIGHT
WORK**