



**SONIC** is a huge family of spotlight/floodlight with COB LED light source. The family offers ground/wall mount fixing, pole clamp and wall clamp array, indirect pole and wall light.

The wide ranges of accessories like glare shield unit, tree strap, earth spike and anchorage bolt kit make **SONIC** customizable for most application. Available in three sizes with a choice of six colors. **SONIC** is fitted with COB LED with high CRI in 2700K, 3000K or 4000K color temperature with 3 SDCM.

The front glass cover is flush to the luminaire housing thus dust and water are not accumulated. High specular reflectors are used in this luminaire family to achieve an outstanding light output ratio.

Aiming can be done through graduated scale by tool. For ease of installation and improved thermal performance the control gear compartment is housed separately to the light engine. **SONIC** is an ideal choice to accentuate sculptures, walls, building facades, bushes and trees.



[www.unilamp.co.th/en/p/sonic](http://www.unilamp.co.th/en/p/sonic)

## Specification

- Designed, manufactured and tested according to IEC 60598.
- LM6 die cast aluminum, extruded aluminum body.
- Stainless steel screws.
- Nano ceramic surface conversion.
- Double layer coating.
- Safety glass cover.
- Post-cured silicone gasket.
- High quality LED module.
- On-Off / 1-10V / DALI control gear.
- Installation must be carried out according to the enclosed product manual.

## Available Color



**\*\*Custom colors are available on request.**

**Mini SONIC – Gear**  
+ Accessory kit for Pole Clamp Solution



**Mega SONIC – Gear**  
+ Accessory kit for Pole Clamp Solution



**Medium SONIC – Gear**  
+ Accessory kit for Pole Clamp Solution



**Mega SONIC – Gear**  
+ Accessory kit for Pole Clamp Solution



Private residence, Bangkok – THAILAND

## • MODULAR SOLUTIONS

### ▪ SONIC + Accessory kit for Pole Mount Solutions

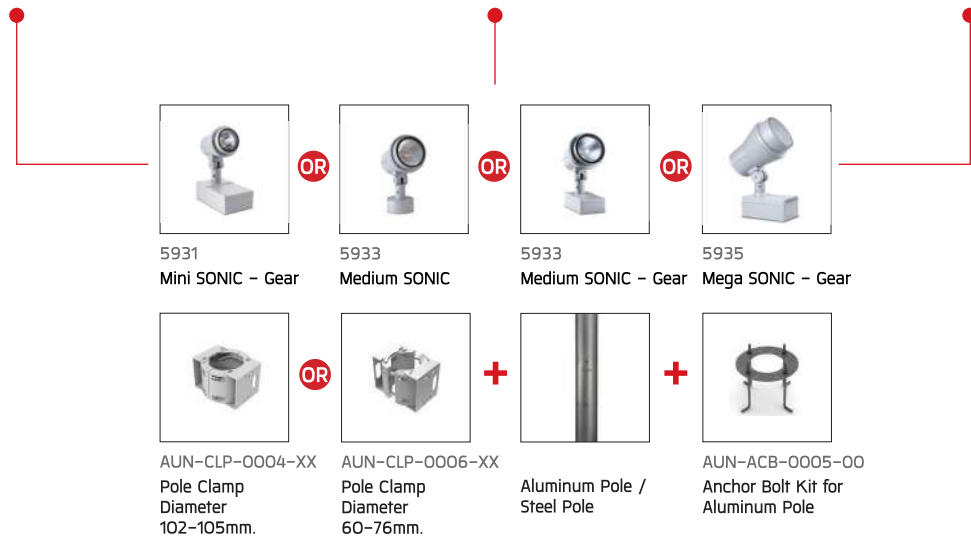
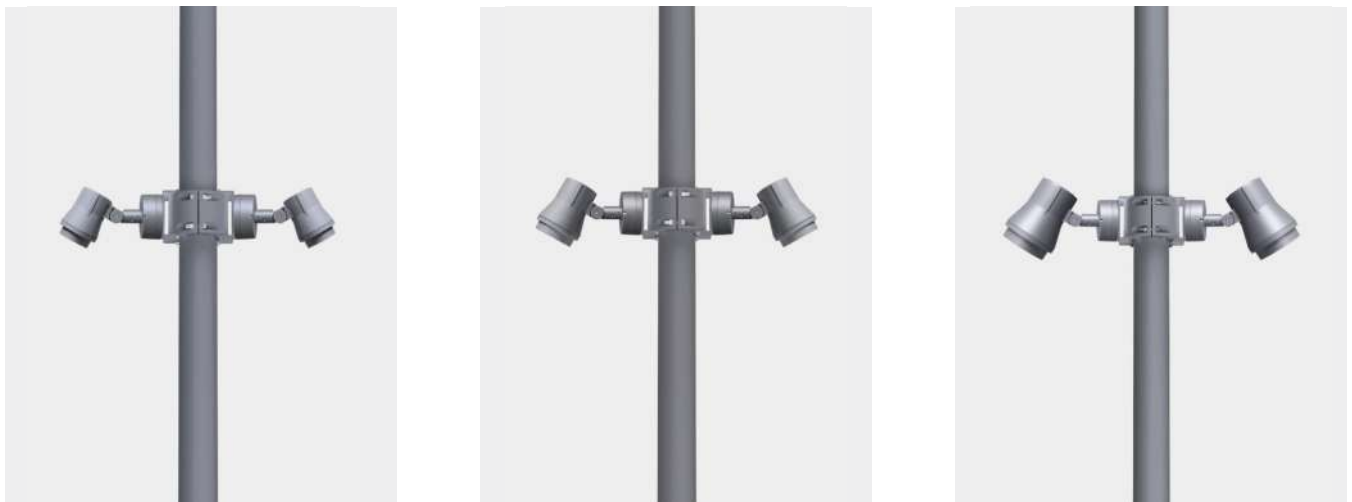

• MODULAR SOLUTIONS





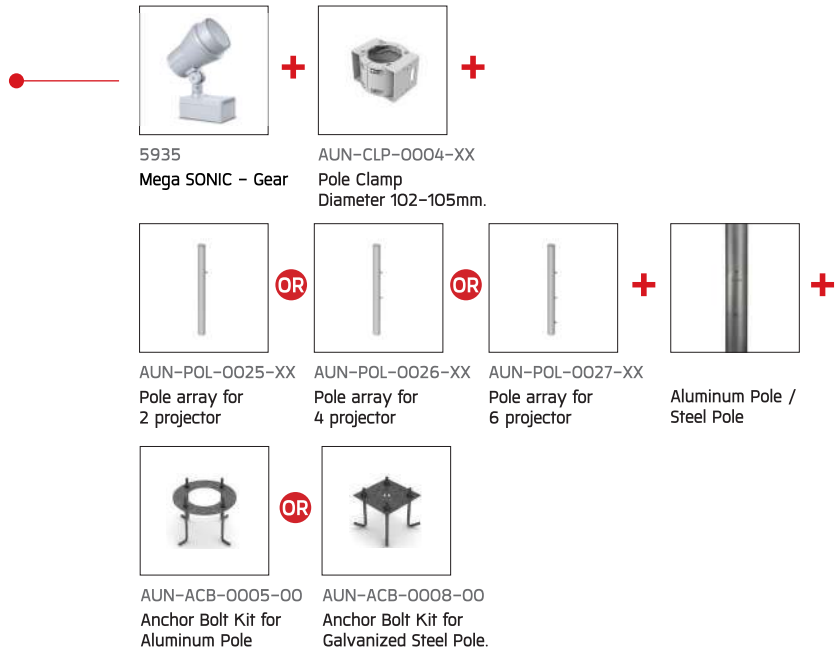
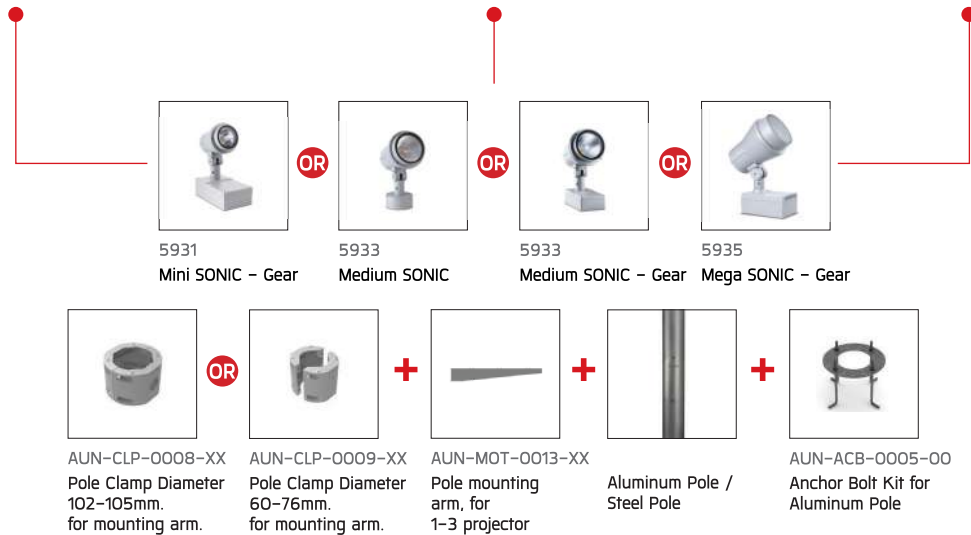



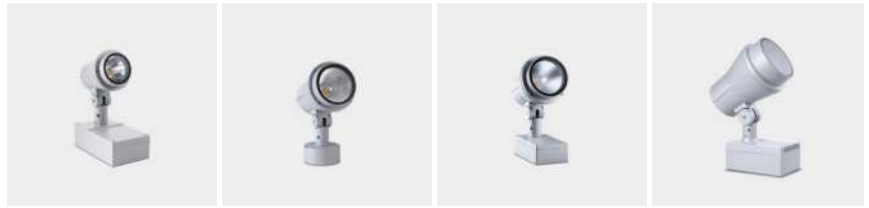





▪ SONIC + Accessory kit for Pole Mount Solutions

\*Pole mounting arm for 1-3 projector is available for installation on 1 or 2 sides  
\*Please see Poles & Anchor bolt section for pole mounting options



## • MODULAR SOLUTIONS



Accessory	Mini SONIC – Gear	Medium SONIC	Medium SONIC – Gear	Mega SONIC – Gear
 Pole Clamp Diameter 102–105mm.	•	•	•	•
 Pole Clamp Diameter 60–76mm.	•	•	•	•
 Pole Clamp Diameter 102–105mm. for mounting arm.	•	•	•	•
 Pole Clamp Diameter 60–76mm. for mounting arm.	•	•	•	•
 Pole mounting arm, for 1–3 projector	•	•	•	•
 Wall array, for 2 projector	–	–	–	•
 Wall array, for 4 projector	–	–	–	•
 Wall array, for 6 projector	–	–	–	•
 Pole array for 2 projector	–	–	–	•
 Pole array for 4 projector	–	–	–	•
 Pole array for 6 projector	–	–	–	•
 Anchor Bolt Kit for Aluminum Pole	•	•	•	•
 Anchor Bolt Kit for Galvanized Steel Pole.	•	•	•	•
 Aluminum Pole	•	•	•	•
 Galvanized Steel Pole	•	•	•	•



Mini SONIC Stand

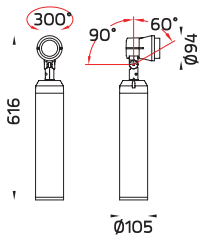

Medium SONIC Stand

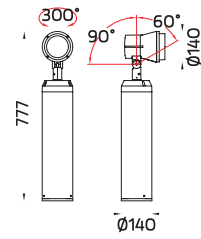

**SONIC**

Application Type : Projector  
Subgroup : Circular

Mini SONIC Stand / 5831										
Medium SONIC Stand / 5833										
<b>Luminaire Performance</b>										
200 - 3720 lm										
8.4 - 41 W										
18 - 104 lm/W										
<b>Beam Options</b>										
<table border="0"> <tr> <td>Narrow</td> <td>Medium</td> <td>Wide</td> <td>Sharp Elliptical H</td> <td>Sharp Elliptical V</td> </tr> <tr> <td></td> <td></td> <td></td> <td></td> <td></td> </tr> </table>	Narrow	Medium	Wide	Sharp Elliptical H	Sharp Elliptical V					
Narrow	Medium	Wide	Sharp Elliptical H	Sharp Elliptical V						
<b>Color Temperature</b>										
2700K / 3000K / 4000K										
<b>Controller</b>										
On-off / On-off [AC LED] / DIM 1-10V / DALI / Remote										
<b>Input Voltage</b>										
24Vdc										
220-240VAC 50/60HZ										

<b>Accessories</b>	
	Glare shield cap
	Ring louver
	Anchor bolt
	IP68 Connector
	CV Driver

# SONIC



## Mini SONIC Gear

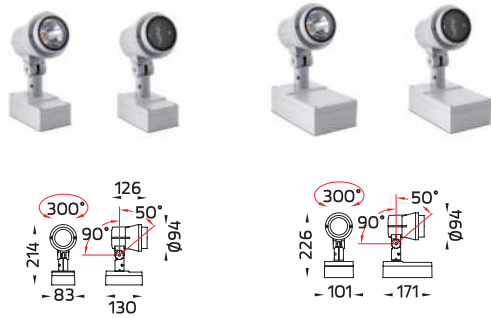

## Medium SONIC Gear

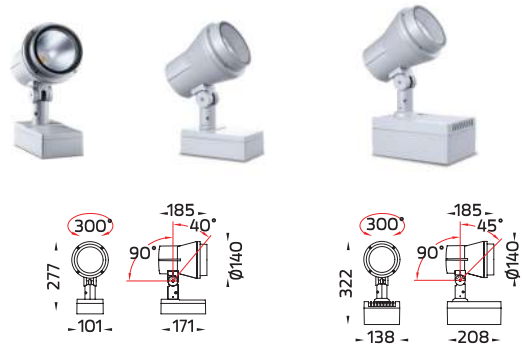

## Medium SONIC

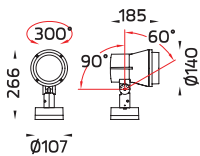

## Mega SONIC Gear

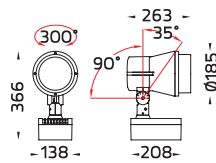

Queen sirikit national convention centre,  
Bangkok - THAILAND

## SONIC

Application Type : Projector

Subgroup : Circular

Mini SONIC / 5931

Medium SONIC / 5933

Mega SONIC / 5935

### Luminaire Performance

200 - 8160 lm

8.4 - 57 W

18 - 143 lm/W

### Beam Options



### Color Temperature

2700K/ 3000K/ 4000K

### Controller

On-off/ On-off [AC LED]/ DIM 1-10V/ DALI/ Remote

### Input Voltage

24Vdc  
220-240VAC 50/60HZ

### Accessories

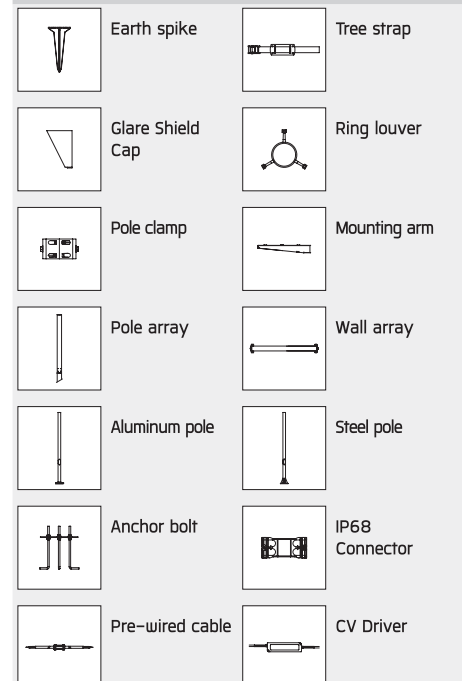

\*Please see Poles & Anchor bolt section for pole mounting options





Mini SONIC Arm Gear

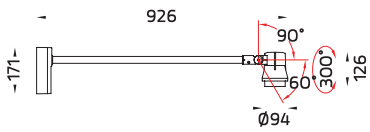

Medium SONIC Arm Gear

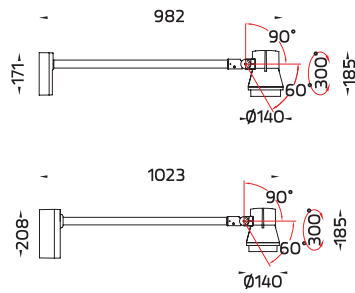

Mega SONIC Arm Gear

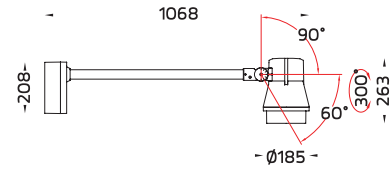

SONIC

Application Type : Projector  
Subgroup : Circular

Mini SONIC Arm / 5932  
Medium SONIC Arm / 5934  
Mega SONIC Arm / 5936

Luminaire Performance

1160 - 8070 lm  
14 - 57 W  
58 - 141 lm/W

Beam Options

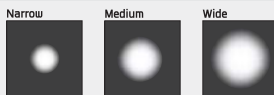

Color Temperature

2700K/ 3000K/ 4000K

Controller

On-off/ On-off [AC LED]/ DIM 1-10V/ DALI

Input Voltage

220-240VAC 50/60HZ

Accessories



Glare shield cap



Ring louver





Product Code	Luminaire Wattage	Beam	CCT	Luminaire Lumen	Efficacy	Controller					Ordering Code				
										REMOTE					
<b>Mini SONIC Stand</b>	 OD-5831	8.4 W	Sharp Elliptical H	2700 K	200 lm	23 lm/W						•	5831-P-7-797-XX		
				3000 K	200 lm	23 lm/W							•	5831-P-7-798-XX	
				4000 K	210 lm	25 lm/W								•	5831-P-7-799-XX
				2700 K	200 lm	23 lm/W								•	5831-Q-7-797-XX
				3000 K	200 lm	23 lm/W								•	5831-Q-7-798-XX
				4000 K	210 lm	25 lm/W								•	5831-Q-7-799-XX
		10 W	Sharp Elliptical H	2700 K	200 lm	20 lm/W	•							5831-P-3-646-XX	
				3000 K	200 lm	20 lm/W	•							5831-P-3-647-XX	
				4000 K	210 lm	21 lm/W	•							5831-P-3-648-XX	
				2700 K	200 lm	20 lm/W				•				5831-P-4-646-XX	
				3000 K	200 lm	20 lm/W				•				5831-P-4-647-XX	
				4000 K	210 lm	21 lm/W				•				5831-P-4-648-XX	
	10 W	Sharp Elliptical V	2700 K	200 lm	20 lm/W	•							5831-Q-3-646-XX		
			3000 K	200 lm	20 lm/W	•							5831-Q-3-647-XX		
			4000 K	210 lm	21 lm/W	•							5831-Q-3-648-XX		
			2700 K	200 lm	20 lm/W				•				5831-Q-4-646-XX		
			3000 K	200 lm	20 lm/W				•				5831-Q-4-647-XX		
			4000 K	210 lm	21 lm/W				•				5831-Q-4-648-XX		
		13 W	Sharp Elliptical H	2700 K	200 lm	20 lm/W								5831-Q-5-646-XX	
				3000 K	200 lm	20 lm/W								5831-Q-5-647-XX	
				4000 K	210 lm	21 lm/W								5831-Q-5-648-XX	
				2700 K	280 lm	21 lm/W								•	5831-P-7-759-XX
				3000 K	280 lm	21 lm/W								•	5831-P-7-760-XX
				4000 K	300 lm	23 lm/W								•	5831-P-7-796-XX
	14 W	13°	2700 K	1380 lm	98 lm/W	•							5831-A-3-901-XX		
			3000 K	1460 lm	104 lm/W	•							5831-A-3-902-XX		
			4000 K	1530 lm	109 lm/W	•							5831-A-3-904-XX		
			2700 K	1380 lm	98 lm/W				•				5831-A-4-503-XX		
			3000 K	1460 lm	104 lm/W				•				5831-A-4-901-XX		
			4000 K	1530 lm	109 lm/W				•				5831-A-4-904-XX		
		14 W	20°	2700 K	1380 lm	98 lm/W								5831-A-5-503-XX	
				3000 K	1460 lm	104 lm/W								5831-A-5-901-XX	
				4000 K	1530 lm	109 lm/W								5831-A-5-904-XX	
				2700 K	1330 lm	95 lm/W	•							5831-B-3-503-XX	
				3000 K	1400 lm	100 lm/W	•							5831-B-3-901-XX	
				4000 K	1460 lm	104 lm/W	•							5831-B-3-904-XX	
	14 W	53°	2700 K	1330 lm	95 lm/W								5831-B-4-503-XX		
			3000 K	1400 lm	100 lm/W								5831-B-4-901-XX		
			4000 K	1460 lm	104 lm/W								5831-B-4-904-XX		
			2700 K	1330 lm	95 lm/W				•				5831-B-5-503-XX		
			3000 K	1400 lm	100 lm/W				•				5831-B-5-901-XX		
			4000 K	1460 lm	104 lm/W				•				5831-B-5-904-XX		
		14 W	26°	2700 K	1300 lm	92 lm/W	•							5831-D-3-503-XX	
				3000 K	1370 lm	97 lm/W	•							5831-D-3-901-XX	
				4000 K	1430 lm	102 lm/W	•							5831-D-3-904-XX	
				2700 K	1300 lm	92 lm/W				•				5831-D-4-503-XX	
				3000 K	1370 lm	97 lm/W				•				5831-D-4-901-XX	
				4000 K	1430 lm	102 lm/W				•				5831-D-4-904-XX	
	15 W	42°	2700 K	1300 lm	92 lm/W								5831-D-5-503-XX		
			3000 K	1370 lm	97 lm/W								5831-D-5-901-XX		
			4000 K	1430 lm	102 lm/W								5831-D-5-904-XX		
			3000 K	1400 lm	93 lm/W	•							5831-6-3-901-XX		
			4000 K	1460 lm	97 lm/W	•							5831-6-3-904-XX		
			3000 K	1350 lm	90 lm/W	•							5831-7-3-901-XX		
	15 W	Sharp Elliptical H	2700 K	280 lm	18 lm/W	•							5831-P-3-630-XX		
			3000 K	280 lm	18 lm/W	•							5831-P-3-644-XX		
			4000 K	300 lm	20 lm/W	•							5831-P-3-645-XX		
			2700 K	280 lm	18 lm/W				•				5831-P-4-630-XX		
			3000 K	280 lm	18 lm/W				•				5831-P-4-644-XX		
			4000 K	300 lm	20 lm/W				•				5831-P-4-645-XX		
		15 W	Sharp Elliptical V	2700 K	280 lm	18 lm/W								5831-P-5-630-XX	
				3000 K	280 lm	18 lm/W								5831-P-5-644-XX	
				4000 K	300 lm	20 lm/W								5831-P-5-645-XX	
				2700 K	280 lm	18 lm/W	•							5831-Q-3-630-XX	
				3000 K	280 lm	18 lm/W	•							5831-Q-3-644-XX	
				4000 K	300 lm	20 lm/W	•							5831-Q-3-645-XX	
	15 W	Sharp Elliptical V	2700 K	280 lm	18 lm/W								5831-Q-4-630-XX		
			3000 K	280 lm	18 lm/W								5831-Q-4-644-XX		
			4000 K	300 lm	20 lm/W								5831-Q-4-645-XX		
			2700 K	280 lm	18 lm/W				•				5831-Q-5-630-XX		
			3000 K	280 lm	18 lm/W				•				5831-Q-5-644-XX		
			4000 K	300 lm	20 lm/W				•				5831-Q-5-645-XX		

\*Please contact sales team for special request.

Product Code	Luminaire Wattage	Beam	CCT	Luminaire Lumen	Efficacy	Controller					Ordering Code
										REMOTE	
<b>OD-5833</b> 	20 W	16°	3000 K	1140 lm	57 lm/W		•				5833-6-3-873-XX
			4000 K	1200 lm	60 lm/W		•				5833-6-3-874-XX
		27 W	23°	3000 K	2710 lm	100 lm/W		•			
	48°		3000 K	2300 lm	85 lm/W		•				5833-7-3-887-XX
		2700 K	2200 lm	81 lm/W		•				5833-7-3-506-XX	
	30 W	14°	4000 K	1990 lm	66 lm/W		•				5833-5-3-878-XX
			2700 K	3720 lm	90 lm/W		•				5833-5-3-505-XX
	41 W	48°	4000 K	3330 lm	81 lm/W		•				5833-7-3-902-XX
			2700 K	3330 lm	81 lm/W		•				5833-7-3-902-XX
	<b>OD-5931</b> 	8.4 W	Sharp Elliptical H	2700 K	200 lm	23 lm/W					•
3000 K				200 lm	23 lm/W					•	5931-P-7-798-XX
4000 K				210 lm	25 lm/W					•	5931-P-7-799-XX
Sharp Elliptical V			2700 K	200 lm	23 lm/W					•	5931-Q-7-797-XX
			3000 K	200 lm	23 lm/W					•	5931-Q-7-798-XX
			4000 K	210 lm	25 lm/W					•	5931-Q-7-799-XX
10 W		Sharp Elliptical H	2700 K	200 lm	20 lm/W		•				5931-P-3-646-XX
			3000 K	200 lm	20 lm/W		•				5931-P-3-647-XX
			4000 K	210 lm	21 lm/W		•				5931-P-3-648-XX
			2700 K	200 lm	20 lm/W			•			5931-P-4-646-XX
	3000 K		200 lm	20 lm/W			•			5931-P-4-647-XX	
	4000 K		210 lm	21 lm/W			•			5931-P-4-648-XX	
10 W	Sharp Elliptical V	2700 K	200 lm	20 lm/W		•				5931-Q-3-646-XX	
		3000 K	200 lm	20 lm/W		•				5931-Q-3-647-XX	
		4000 K	210 lm	21 lm/W		•				5931-Q-3-648-XX	
		2700 K	200 lm	20 lm/W			•			5931-Q-4-646-XX	
		3000 K	200 lm	20 lm/W			•			5931-Q-4-647-XX	
		4000 K	210 lm	21 lm/W			•			5931-Q-4-648-XX	
	Sharp Elliptical H	2700 K	200 lm	20 lm/W				•		5931-Q-5-646-XX	
		3000 K	200 lm	20 lm/W				•		5931-Q-5-647-XX	
		4000 K	210 lm	21 lm/W				•		5931-Q-5-648-XX	
		2700 K	280 lm	21 lm/W					•	5931-P-7-759-XX	
		3000 K	280 lm	21 lm/W					•	5931-P-7-760-XX	
		4000 K	300 lm	23 lm/W					•	5931-P-7-796-XX	
13 W	Sharp Elliptical H	2700 K	280 lm	21 lm/W					•	5931-Q-7-759-XX	
		3000 K	280 lm	21 lm/W					•	5931-Q-7-760-XX	
		4000 K	300 lm	23 lm/W					•	5931-Q-7-796-XX	
		2700 K	1380 lm	98 lm/W		•				5931-A-3-503-XX	
		3000 K	1460 lm	104 lm/W		•				5931-A-3-901-XX	
		4000 K	1530 lm	109 lm/W		•				5931-A-3-904-XX	
14 W	13°	2700 K	1380 lm	98 lm/W			•			5931-A-4-503-XX	
		3000 K	1460 lm	104 lm/W			•			5931-A-4-901-XX	
		4000 K	1530 lm	109 lm/W			•			5931-A-4-904-XX	
		2700 K	1380 lm	98 lm/W				•		5931-A-5-503-XX	
		3000 K	1460 lm	104 lm/W				•		5931-A-5-901-XX	
		4000 K	1530 lm	109 lm/W				•		5931-A-5-904-XX	
14 W	20°	2700 K	1330 lm	95 lm/W		•				5931-B-3-503-XX	
		3000 K	1400 lm	100 lm/W		•				5931-B-3-901-XX	
		4000 K	1460 lm	104 lm/W		•				5931-B-3-904-XX	
		2700 K	1330 lm	95 lm/W			•			5931-B-4-503-XX	
		3000 K	1400 lm	100 lm/W			•			5931-B-4-901-XX	
		4000 K	1460 lm	104 lm/W			•			5931-B-4-904-XX	
14 W	53°	2700 K	1330 lm	95 lm/W				•		5931-B-5-503-XX	
		3000 K	1400 lm	100 lm/W				•		5931-B-5-901-XX	
		4000 K	1460 lm	104 lm/W				•		5931-B-5-904-XX	
		2700 K	1300 lm	92 lm/W		•				5931-D-3-503-XX	
		3000 K	1370 lm	97 lm/W		•				5931-D-3-901-XX	
		4000 K	1430 lm	102 lm/W		•				5931-D-3-904-XX	
14 W	53°	2700 K	1300 lm	92 lm/W				•		5931-D-4-503-XX	
		3000 K	1370 lm	97 lm/W				•		5931-D-4-901-XX	
		4000 K	1430 lm	102 lm/W				•		5931-D-4-904-XX	
		2700 K	1300 lm	92 lm/W					•	5931-D-5-503-XX	
		3000 K	1370 lm	97 lm/W					•	5931-D-5-901-XX	
		4000 K	1430 lm	102 lm/W					•	5931-D-5-904-XX	
15 W	13°	3000 K	1460 lm	97 lm/W		•				5931-5-3-901-XX	
		4000 K	1530 lm	102 lm/W		•				5931-5-3-904-XX	
		2700 K	1380 lm	92 lm/W		•				5931-5-3-503-XX	
15 W	13°	3000 K	1460 lm	97 lm/W				•		5931-5-4-901-XX	
		3000 K	1460 lm	97 lm/W				•		5931-5-5-901-XX	
		4000 K	1460 lm	97 lm/W				•		5931-5-5-901-XX	
15 W	26°	3000 K	1400 lm	93 lm/W		•				5931-6-3-901-XX	
		4000 K	1460 lm	97 lm/W		•				5931-6-3-904-XX	
		2700 K	1330 lm	88 lm/W		•				5931-6-3-503-XX	
15 W	26°	3000 K	1400 lm	93 lm/W				•		5931-6-5-901-XX	
		4000 K	1460 lm	97 lm/W				•		5931-6-5-904-XX	
		2700 K	1350 lm	90 lm/W		•				5931-7-3-901-XX	
15 W	42°	4000 K	1410 lm	94 lm/W		•				5931-7-3-904-XX	
		2700 K	1280 lm	85 lm/W		•				5931-7-3-503-XX	

	Product Code	Luminaire Wattage	Beam	CCT	Luminaire Lumen	Efficacy	Controller					Ordering Code	
											REMOTE		
Mini SONIC	OD-5931	15 W	Sharp Elliptical V	2700 K	280 lm	18 lm/W	•					5931-P-3-630-XX	
				3000 K	280 lm	18 lm/W	•					5931-P-3-644-XX	
				4000 K	300 lm	20 lm/W	•					5931-P-3-645-XX	
				2700 K	280 lm	18 lm/W			•			5931-P-4-630-XX	
				3000 K	280 lm	18 lm/W			•			5931-P-4-644-XX	
				4000 K	300 lm	20 lm/W			•			5931-P-4-645-XX	
	Gear	15 W	Sharp Elliptical V	2700 K	280 lm	18 lm/W				•		5931-P-5-630-XX	
				3000 K	280 lm	18 lm/W				•		5931-P-5-644-XX	
				4000 K	300 lm	20 lm/W				•		5931-P-5-645-XX	
				2700 K	280 lm	18 lm/W	•					5931-Q-3-630-XX	
				3000 K	280 lm	18 lm/W	•					5931-Q-3-644-XX	
				4000 K	300 lm	20 lm/W	•					5931-Q-3-645-XX	
Medium SONIC	OD-5933	20 W	10°	3000 K	1210 lm	60 lm/W		•				5933-5-3-873-XX	
				4000 K	1270 lm	63 lm/W		•				5933-5-3-874-XX	
			16°	3000 K	1140 lm	57 lm/W		•				5933-6-3-873-XX	
				4000 K	1200 lm	60 lm/W		•				5933-6-3-874-XX	
			38°	3000 K	1160 lm	58 lm/W		•				5933-7-3-873-XX	
				4000 K	1220 lm	61 lm/W		•				5933-7-3-874-XX	
	30 W	14°	3000 K	1890 lm	63 lm/W		•				5933-5-3-877-XX		
			4000 K	1990 lm	66 lm/W		•				5933-5-3-878-XX		
		22°	3000 K	1770 lm	59 lm/W		•				5933-6-3-877-XX		
			4000 K	1820 lm	60 lm/W		•				5933-7-3-877-XX		
	OD-5933	27 W	12°	3000 K	2680 lm	99 lm/W	•					5933-5-3-887-XX	
				4000 K	2680 lm	99 lm/W			•			5933-5-4-887-XX	
27 W		23°	3000 K	2710 lm	100 lm/W	•					5933-6-3-887-XX		
			4000 K	2780 lm	102 lm/W	•					5933-6-3-891-XX		
27 W		48°	2700 K	2590 lm	95 lm/W	•					5933-6-3-506-XX		
			3000 K	2710 lm	100 lm/W			•			5933-6-4-887-XX		
Medium SONIC – Gear	OD-5933	27 W	48°	4000 K	2780 lm	102 lm/W				•		5933-6-4-891-XX	
				3000 K	2300 lm	85 lm/W	•					5933-7-3-887-XX	
		27 W	48°	4000 K	2360 lm	87 lm/W	•					5933-7-3-891-XX	
				2700 K	2200 lm	81 lm/W	•					5933-7-3-506-XX	
		27 W	48°	3000 K	2300 lm	85 lm/W			•			5933-7-4-887-XX	
				4000 K	2360 lm	87 lm/W			•			5933-7-4-891-XX	
	41 W	12°	3000 K	3890 lm	94 lm/W	•					5933-5-3-902-XX		
			4000 K	4000 lm	97 lm/W	•					5933-5-3-905-XX		
		41 W	23°	2700 K	3720 lm	90 lm/W	•					5933-5-3-505-XX	
				3000 K	3930 lm	95 lm/W	•					5933-6-3-902-XX	
	Mega SONIC – Gear	OD-5935	57 W	17°	2700 K	3770 lm	91 lm/W				•		5933-6-3-505-XX
					3000 K	3930 lm	95 lm/W				•		5933-6-5-505-XX
4000 K					3930 lm	95 lm/W	•					5933-6-5-902-XX	
57 W			48°	3000 K	3330 lm	81 lm/W	•					5933-7-3-902-XX	
				4000 K	3420 lm	83 lm/W	•					5933-7-3-905-XX	
				3000 K	3330 lm	81 lm/W				•		5933-7-5-902-XX	
57 W	17°	3000 K	770 lm	136 lm/W	•					5935-5-3-888-XX			
		4000 K	8160 lm	143 lm/W	•					5935-5-3-892-XX			
		2700 K	6470 lm	113 lm/W	•					5935-5-3-508-XX			
	57 W	24°	3000 K	770 lm	136 lm/W				•		5935-5-5-888-XX		
			4000 K	8160 lm	143 lm/W				•		5935-5-5-892-XX		
			3000 K	7680 lm	134 lm/W	•					5935-6-3-888-XX		
	57 W	37°	4000 K	8070 lm	141 lm/W	•					5935-6-3-892-XX		
			4000 K	8070 lm	141 lm/W				•		5935-6-5-892-XX		
			2700 K	6320 lm	110 lm/W	•					5935-7-3-888-XX		
57 W	37°	4000 K	7970 lm	139 lm/W	•					5935-7-3-892-XX			
		4000 K	7970 lm	139 lm/W				•		5935-7-4-892-XX			
		3000 K	7590 lm	133 lm/W				•		5935-7-5-888-XX			
				4000 K	7970 lm	139 lm/W				•		5935-7-5-892-XX	

Product Code	Luminaire Wattage	Beam	CCT	Luminaire Lumen	Efficacy	Controller					Ordering Code
						⏻	AC LED	1-10V	DALI	REMOTE	
Mini SONIC Arm 	14 W	13°	4000 K	1530 lm	109 lm/W				•		5932-A-5-904-XX
			2700 K	1330 lm	95 lm/W	•				5932-B-3-503-XX	
			3000 K	1400 lm	100 lm/W	•				5932-B-3-901-XX	
			4000 K	1460 lm	104 lm/W	•				5932-B-3-904-XX	
	14 W	20°	2700 K	1330 lm	95 lm/W			•		5932-B-4-503-XX	
			3000 K	1400 lm	100 lm/W			•		5932-B-4-901-XX	
			4000 K	1460 lm	104 lm/W			•		5932-B-4-904-XX	
			2700 K	1330 lm	95 lm/W				•	5932-B-5-503-XX	
	14 W	53°	2700 K	1300 lm	92 lm/W	•				5932-D-3-503-XX	
			3000 K	1370 lm	97 lm/W	•				5932-D-3-901-XX	
			4000 K	1430 lm	102 lm/W	•				5932-D-3-904-XX	
			2700 K	1300 lm	92 lm/W			•		5932-D-4-503-XX	
	14 W	53°	3000 K	1370 lm	97 lm/W			•		5932-D-4-901-XX	
			4000 K	1430 lm	102 lm/W			•		5932-D-4-904-XX	
			2700 K	1300 lm	92 lm/W				•	5932-D-5-503-XX	
			3000 K	1370 lm	97 lm/W				•	5932-D-5-901-XX	
	14 W	53°	4000 K	1430 lm	102 lm/W				•	5932-D-5-904-XX	
			3000 K	1460 lm	97 lm/W	•				5932-5-3-901-XX	
			2700 K	1380 lm	92 lm/W	•				5932-5-3-503-XX	
			3000 K	1400 lm	93 lm/W	•				5932-6-3-901-XX	
	15 W	26°	2700 K	1330 lm	88 lm/W	•				5932-6-3-503-XX	
3000 K			1350 lm	90 lm/W	•				5932-7-3-901-XX		
42°		4000 K	1410 lm	94 lm/W	•				5932-7-3-904-XX		
		3000 K	1460 lm	97 lm/W	•						
Medium SONIC Arm 	20 W	38°	3000 K	1160 lm	58 lm/W		•			5934-7-3-873-XX	
	27 W	23°	3000 K	2710 lm	100 lm/W	•				5934-6-3-887-XX	
		48°	3000 K	2300 lm	85 lm/W	•				5934-7-3-887-XX	
	30 W	47°	3000 K	1820 lm	60 lm/W		•			5934-7-3-877-XX	
41 W	23°	3000 K	3930 lm	95 lm/W	•					5934-6-3-902-XX	
	48°	3000 K	3330 lm	81 lm/W	•					5934-7-3-902-XX	
Mega SONIC Arm 	57 W	24°	4000 K	8070 lm	141 lm/W	•				5936-6-3-892-XX	
		37°	3000 K	7590 lm	133 lm/W	•				5936-7-3-888-XX	



Siam Power, Nonthaburi – THAILAND